





DIST 

DIST 

DIST 2 sec 

1x 

2x 

3x 

1x 

DIST 

ON

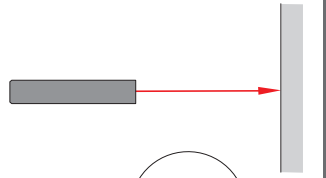

C OFF 
2 sec

OFF



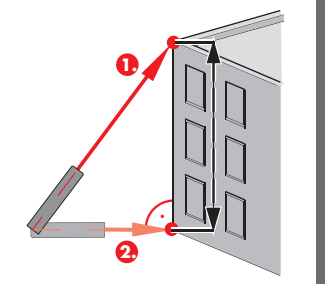
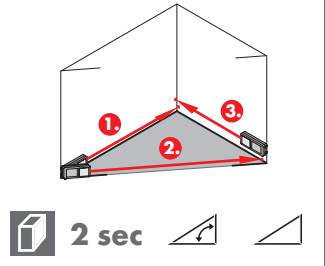
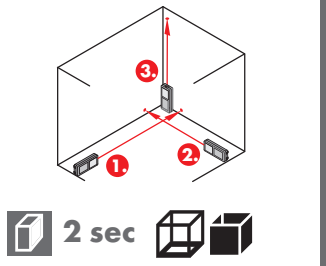
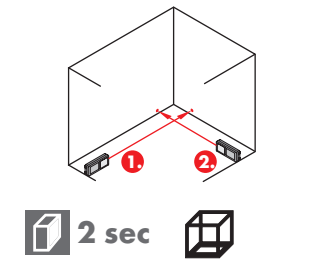

min.

max.





2x 

3x 

4x 

1x 

2x 

3x 

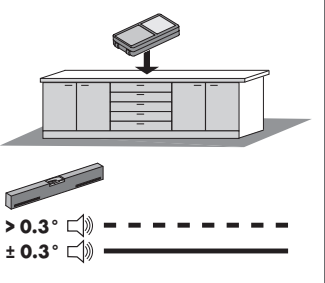
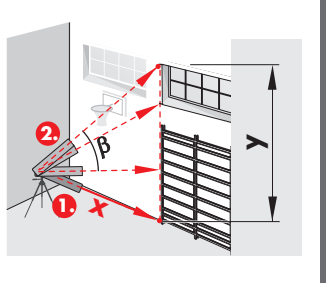
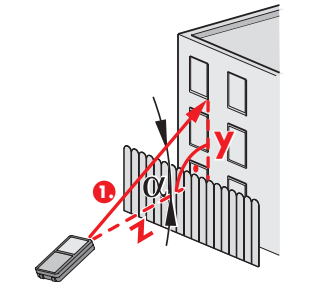
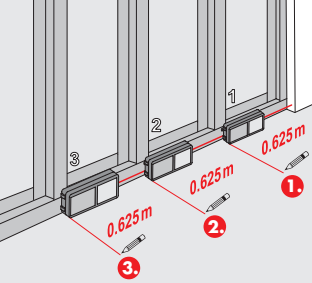
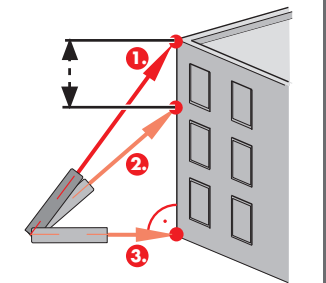
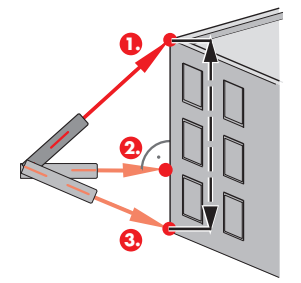



 **2** 

Laser class 2 in acc. to IEC 60825-1



L C X A 8 0 7 5 8 6

www.DEWALT.com
www.DEWALT.eu

TIMER

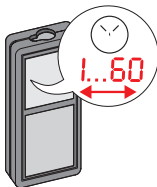

Adjust delay of automatic release

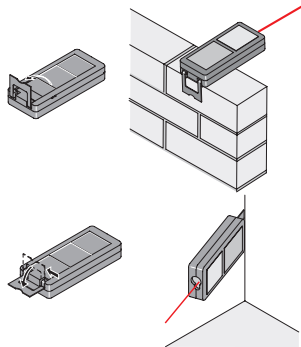
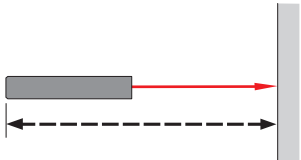
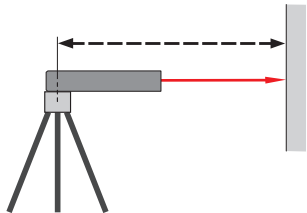
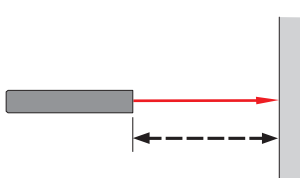

1...20
8.294 m



History (1-20)

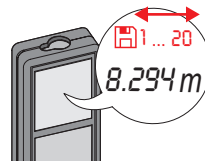

DEWALT DW03101

QUICKSTART

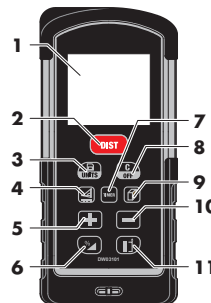

- 1 Display
- 2 On / Measure
- 3 Units / Memory
- 4 Pythagoras / Stake out
- 5 Add
- 6 Smart Horizontal Mode / Height Tracking / Inclination
- 7 Timer
- 8 Clear / Off
- 9 Area / Volume / Triangular area
- 10 Subtract
- 11 Measuring reference



2 sec = Units



- 2 sec



+ 2 sec



2 sec



% 2 sec

0.0° 0.0%

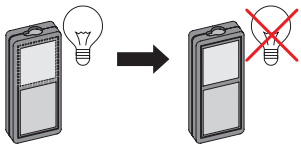

History (1-20)

